

Article number: 20992V35M10

Description: E+G Threaded end-caps - GN 992-V35-M10

Measures

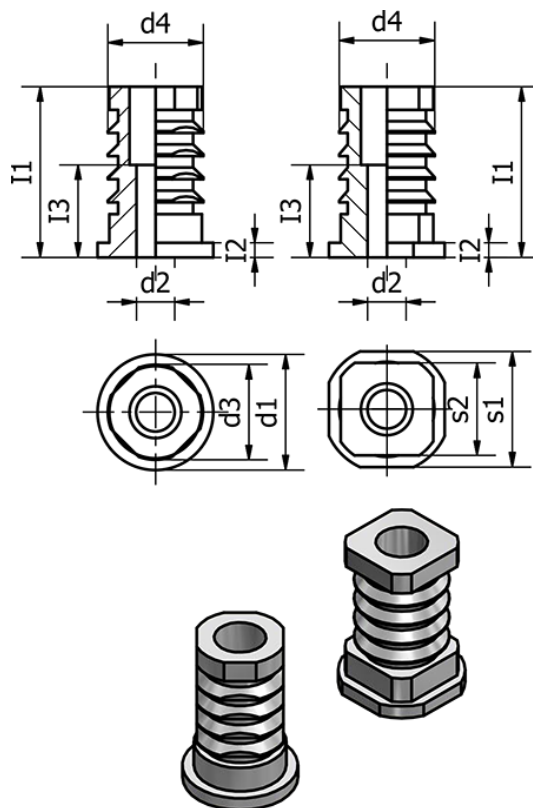

d1 =	s2 = 31
d2 = 10	Weight (g) = 60
d3 =	
d4 = 31.5	
I1 = 37.5	
I2 = 2.5	
I3 = 24	
s1 = V35	